



RP..A type pressure reducing valves - 3 way

- Pilot operated
- With relieving
- Spool type
- From SAE10 to SAE16 cavities

Technical specifications and diagrams are measured with mineral oil of 46 cSt viscosity at 40°C (104°F) temperature.

	RP10A	RP12A	RP16A
Nominal flow	50 l/min (7.9 US gpm)	100 l/min (26 US gpm)	150 l/min (40 US gpm)
Max. pressure	350 bar (5100 psi)		
Oil leakage	-		
Fluid	mineral based oil		
Viscosity	10-200 cSt		
Max level of contamination	20/18/14 ISO4406		
Fluid temperature	with NBR seals with FPM seals	from -20°C (-4°F) to 80°C (176°F) from -20°C (-4°F) to 100°C (212°F)	
Environmental temp. for working conditions	from -20°C (-4°F) to 50°C (122°F)		
Cavity	SAE 10/3	SAE 12/3	SAE 16/3
Weight	0.210 kg (0.46 lb)	0.330 kg (0.72 lb)	0.420 kg (0.92 lb)

NOTE - For different conditions, please contact Walvoil Sales Dpt.

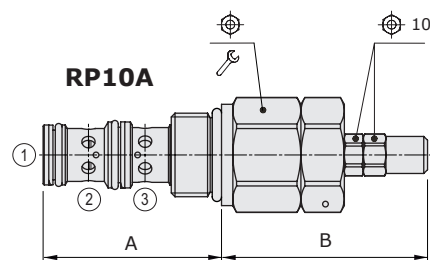
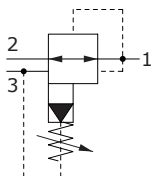

Valve type	A		B		⌀	Nm	lbft
	mm	in	mm	in			
RP10A/1S	47.2	1.86	54.5	2.15	27	50	37
RP12A/0S	73.5	2.89	51.5	2.03	32	80	59
RP16A/0S	75	2.95	50.5	1.99	41	100	74

For dimensions with different type of adjustment see page 212

Ordering codes and description composition

RP10A/1S1B

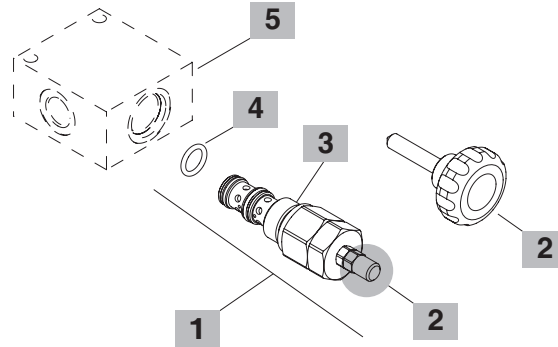
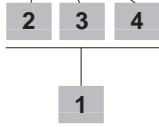

1 Cartridges

TYPE	CODE	DESCRIPTION
SAE cavity 10/3		
RP10A/1S1B	ORP10002016	Pressure range 1
RP10A/1S2B	ORP10002017	Pressure range 2
RP10A/1S3B	ORP10002018	Pressure range 3
SAE cavity 12/3		
RP12A/0S1B	ORP12002002	Pressure range 1
RP12A/0S2B	ORP12002003	Pressure range 2
RP12A/0S3B	ORP12002000	Pressure range 3
SAE cavity 16/3		
RP16A/0S1B	ORP16002006	Pressure range 1
RP16A/0S2B	ORP16002000	Pressure range 2
RP16A/0S3B	ORP16002011	Pressure range 3

2 Adjustments

TYPE	DESCRIPTION
S	Screw with cap
V	With handwheel

3 Pressure range

Standard setting is referred to at 5 l/min (1.32 US gpm) flow

TYPE	DESCRIPTION
1	Pressure range 5÷80 bar (72.5÷1160 psi); Std. setting 50 bar (725 psi) at 5 l/min (1.32 US gpm)
2	Pressure range 50÷220 bar (725÷3190 psi); Std. setting 150 bar (2175 psi) at 5 l/min (1.32 US gpm)
3	For SAE cavity 10/3: pressure range 100÷350 bar (1450÷5075 psi); Std. setting 250 bar (3625 psi) For SAE cavity 12/3 and 16/3: pressure range 180÷350 bar (2610÷5075 psi); Std. setting 250 bar (3625 psi)

4 Seals

TYPE	DESCRIPTION
B	NBR (Buna) o-ring seals, std configuration
V	FPM (Viton) o-ring seals, contact Sales Dept.

5 Valve body

TYPE	CODE	DESCRIPTION
SAE 10/3-G 3/8	3CC1030C11	Aluminium body for cavity 10 valve, G 3/8 std thread
SAE 12/3-G 1/2	3CC1230D11	Aluminium body for cavity 12 valve, G 1/2 std thread
SAE 16/3-G 3/4	3CC1630E11	Aluminium body for cavity 16 valve, G 3/4 std thread

Note: aluminium body can stand up to 210 bar (3050 psi)
For steel bodies or different threading see from page 217

RP10A pressure drop vs. flow

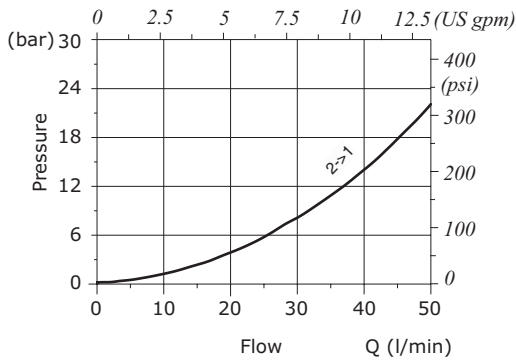

RP10A reducing/relieving pressure vs. flow

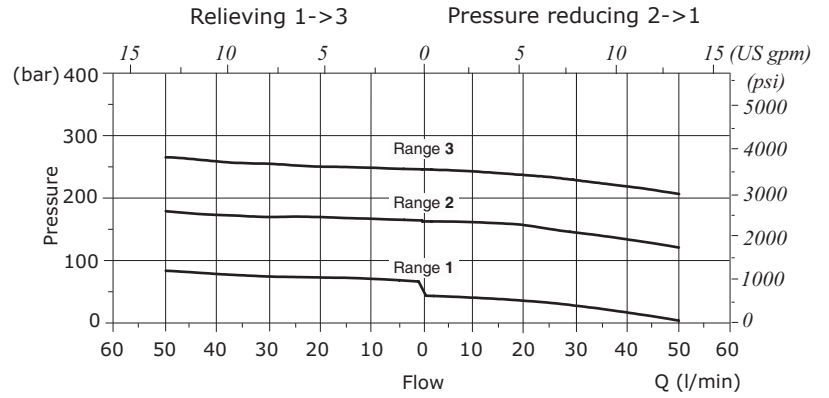

RP12A pressure drop vs. flow

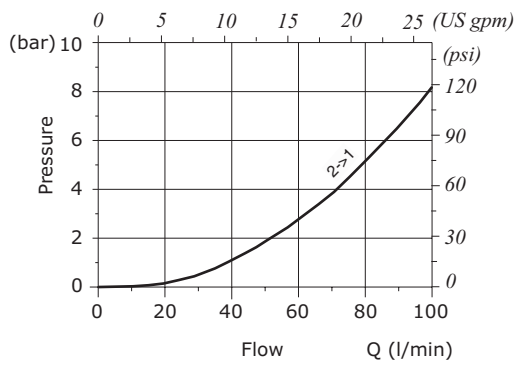

RP12A reducing/relieving pressure vs. flow

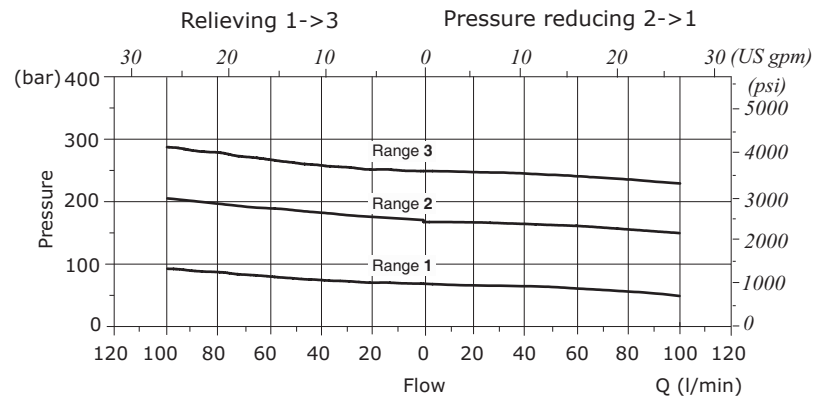

RP16A pressure drop vs. flow

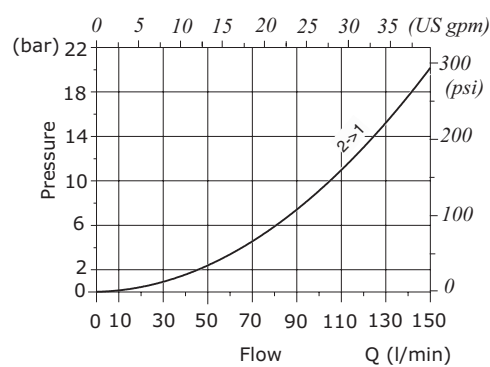

RP16A reducing/relieving pressure vs. flow

