



Handle 10 series

- Cylindrical Ø 39 mm / Ø 1.53 in in Nylon®
- ON/OFF control with push button or rocker switch

General features

Cap material	Neoprene
Body material	Nylon®
IP weather protection (assembled)	IP44
Ambient temperature	from -20°C to 60°C / from -4°F to 140°F

Electric devices features

ON/OFF push-button

Version	spring return
Contact type	NA
Current rating	6 A resistive load 4 A inductive load @ 30 VDC
Mechanical life (nr. of operations)	3x10 ⁶
Electric life (nr. of operations)	10 ⁵
Weather protection	IP54

Cables

Conductor material	Copper with tinned ends
Conductor section	AWG20
Insulating material	PVC
Protective covering material	PVC

Dimensions

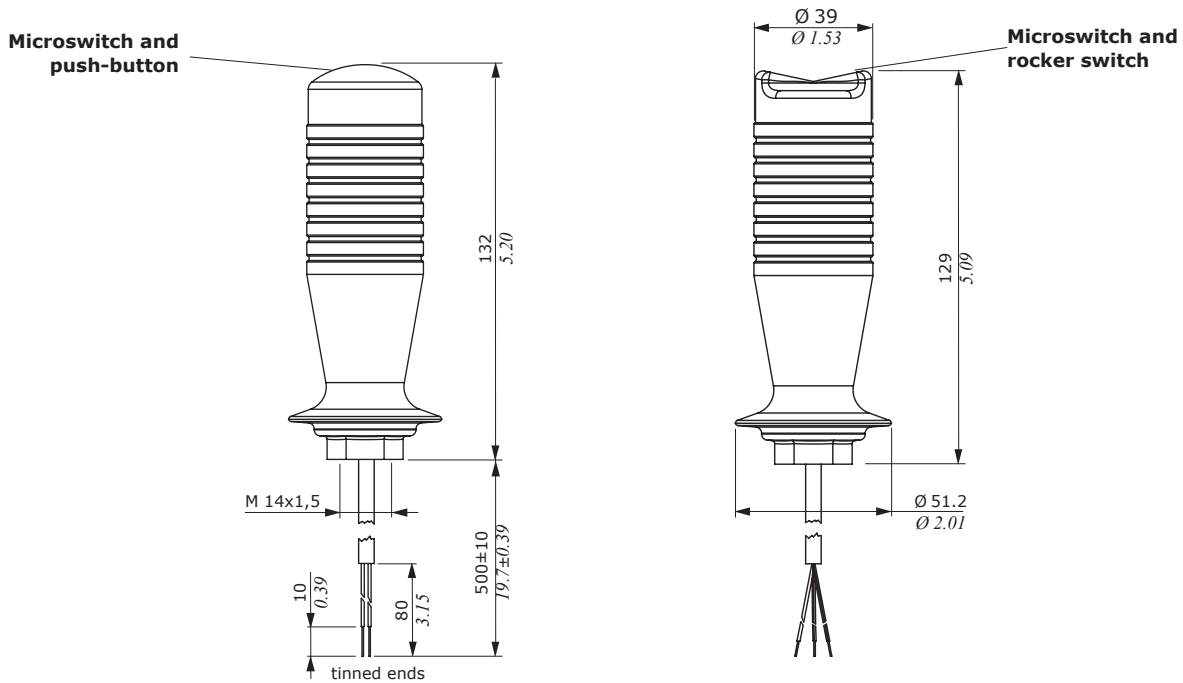

Configurations

No push-button control

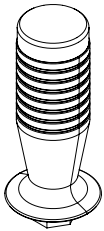

Code	5IMP100000
Description	WI
Configuration	Senza pulsante

Push-button control

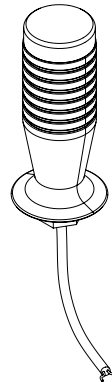

Code	5IMP200000	5IMP500000
Description	XI/C	KI/C
Configuration	Tipo (ON)/OFF	Tipo protetto (ON)/OFF

Scheme

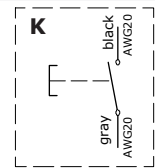
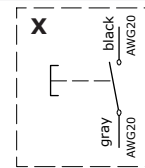

Rocker switch control

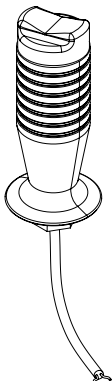

Code	5IMP600000	5IMP400000	5IMP300000
Description	TI/C	YI/C	ZI/C
Configuration	ON/OFF/ON type	(ON)/OFF/(ON) type	ON/OFF type

Scheme

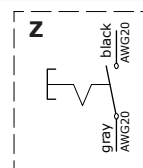
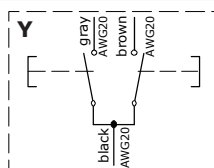
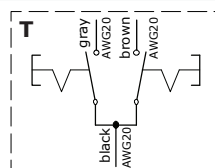

NOTE - For different joint see page 4.

For different handle configurations, contact our Sales Dept.